

Smart Solutions Series

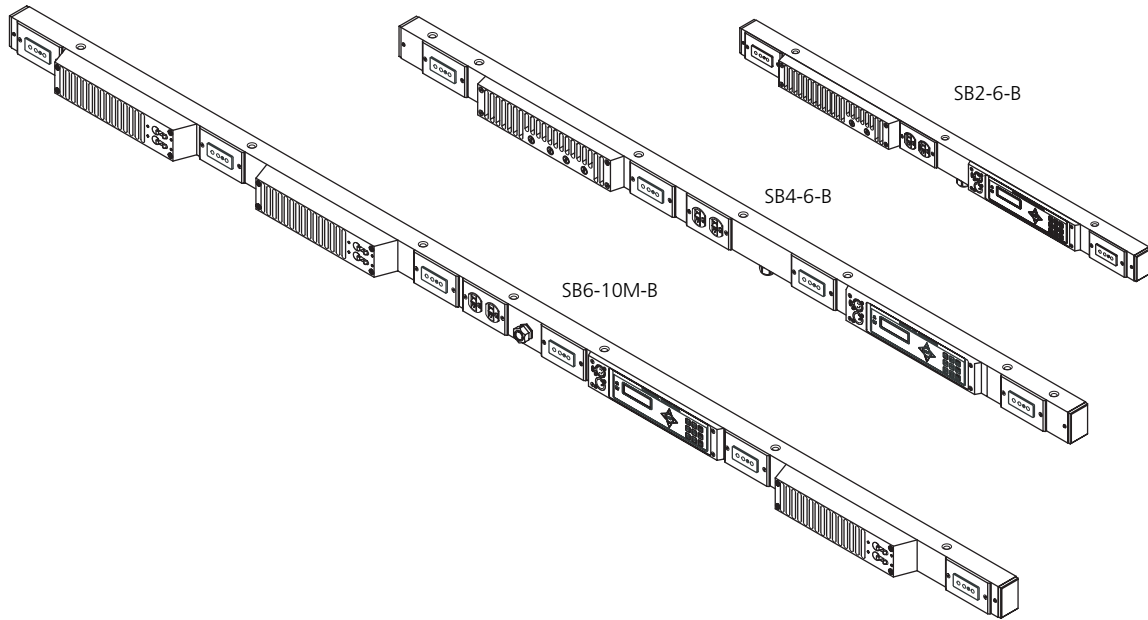

GENERAL INFORMATION

SmartBars are small linear dimmer bars that allow direct fixture mounting. Simple to use, the SmartBar provides a practical and versatile distributed dimming solution for small venues, rental applications and industrial presentations. The only connections needed are main power and DMX data.

APPLICATIONS Applications requiring distributed dimming and position flexibility:
 Industrial productions
 Rental productions
 Convention and conference centers
 Multi-use venues: gymnasiums, cafeteriums, multimedia rooms
 TV Studios
 Casinos
 Discos

FEATURES Suitable for portable or permanent installation
 2, 4 or 6 dimmer versions available
 Digital forward-phase dimming
 Convection cooled
 Integrated suspension points for fixtures
 Choice of output connectors
 DMX 512 compliant
 LCD display with graphic channel level indication
 Local manual control, built-in presets and sequencer for stand alone operation
 User-selectable dimmer curves
 Individual channel features: non-dim, max & min levels, response speed

ORDERING INFORMATION

SmartBar

Model#	Description
SB2-6-A	2 x 6A (720W) SmartBar with Edison connectors
SB2-6-B	2 x 6A (720W) SmartBar with Stage Pin connectors
SB2-6-C	2 x 6A (720W) SmartBar with Twist-Lok connectors
SB4-6-A	4 x 6A (720W) SmartBar with Edison connectors
SB4-6-B	4 x 6A (720W) SmartBar with Stage Pin connectors
SB4-6-C	4 x 6A (720W) SmartBar with Twist-Lok connectors
SB2-10M-A	2 x 10A (1200W) SmartBar with Edison connectors
SB2-10M-B	2 x 10A (1200W) SmartBar with Stage Pin connectors
SB2-10M-C	2 x 10A (1200W) SmartBar with Twist-Lok connectors
SB6-10M-A	6 x 10A (1200W) SmartBar with Edison connectors
SB6-10M-B	6 x 10A (1200W) SmartBar with Stage Pin connectors
SB6-10M-C	6 x 10A (1200W) SmartBar with Twist-Lok connectors

SmartBar Accessories

Model#	Description
400CC	C-Clamps
400SC	Safety cable
ST	SmartStand and adapter (casters optional)

Suggested Fixtures

Model#	Description
S4 jr	Source Four junior or junior zoom ellipsoidals
S4 PAR	Source Four PAR EA or MCM*
S4	Source Four ellipsoidals*

* Lamped at 375W or 575W based on SmartBar power capacity



SPECIFICATIONS

GENERAL	<p>2, 4 or 6 dimmer versions available</p> <p>2 x 6A and 4 x 6A</p> <p>2 x 10A and 6 x 10A</p> <p>UL Listed and cUL approved</p> <p>Installation requires attachment of safety cables, main power via flexible cable and data via DMX</p>
MECHANICAL	<p>Manufactured of strong, thick walled aluminum with a black anodized finish</p> <p>Integrated sleeved suspension points for fixtures and for mounting hardware (C-clamps or stand adapters)</p> <p>Supplied with five 3-1/2" long, 1/2" bolts and appropriate hardware for fixture mounting</p> <p>Convection cooled - operates without cooling fans or filters.</p>
ELECTRICAL	<p>120/208V 60Hz Mains supply</p> <p>2 x 6A, 4 x 6A and 2 x 10A: Single phase 2-wire plus ground, 20A feed</p> <p>6 x 10A: Three phase 4-wire plus ground, 20A feed</p> <p>Total load can not exceed capacity of main power connection (wall outlet, 15A, 20A)</p> <p>Power wiring by use of an attached flexible 10' 50 feed cord and bare-ends (connector not supplied)</p> <p>10W Minimum load per dimmer</p> <p>Edison, Stage Pin or Twist-Lok outlets (1 per circuit)</p> <p>Single duplex auxiliary outlet centered on bar</p> <p>6A units: fuse for load protection per dimmer</p> <p>10A units: circuit breaker for load protection</p> <p>Quality rise time filtering measured at 120us (6A) and 320us(10A)</p>

THERMAL	<p>Maximum operating temperature 172°F (78° C)</p> <p>Humidity between 30 – 95% non-condensing</p> <p>Natural convection cooling from front-mounted heatsinks</p> <p>Optimum cooling when mounted horizontally with the control panel vertical</p>
CONTROL FEATURES	<p>DMX512 In and Thru via 5Pin XLR connectors,</p> <p>Supports up to 32 SmartBars on one DMX line</p> <p>High contrast 2-line by 20-character backlit LCD with graphic channel level indication</p> <p>9-button keypad plus arrow array and Enter button</p> <p>2 status LED indicators: Power and Valid DMX</p> <p>Soft patch any dimmer to any DMX channel</p> <p>Programmable options per channel: max/ min levels, response time, non-dim operation, dimmer curve</p> <p>Local manual control and 20 preset chase patterns for stand alone operation</p> <p>Programmable start modes with soft start for higher wattage lamps and burst start for cold filaments</p> <p>DMX Backup settings - Selectable Data Loss Behavior</p> <p>Password protection for access to DMX, Configuration and Install menus</p>

CONTROL PANEL

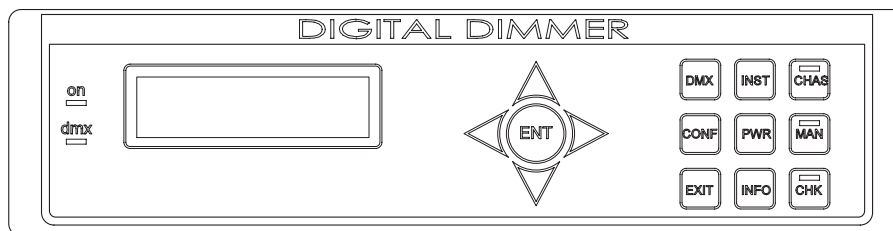

ENT & cursor arrows: ENT (Enter) completes a programming step and records the information in the memory. The four cursor arrows provide navigation through the set-up menu, and the means to enter data.

DMX: Selects DMX address per channel when the single mode is selected or the first address of the group when the joined mode is selected.

INST: Install function. To set-up dimmer functionality during installation with options as follows:

- DMX configuration (individual or combined)
- Channel configuration (individual or combined)
- Channel information
- Password set-up
- Dimmer hardware configuration
- Minimum level reset (preheat off when DMX is not present)
- Factory reset
- Sleep mode
- DMX backup levels
- DMX failure options

CHAS (with LED): Chase. Provides set-up for the dimmer's internal chase system for stand-alone display effects (The LED illuminates when the dimmer is in the 'chase mode)

CONF: Configure. Access to a sub-menu to set the detailed configuration for individual or combined dimmer channels

PWR: Power. This function is not available in this product line.

MAN: Manual. Provides manual control of each channel for circuit testing and pre-setting

EXIT: Returns to the opening screen menu option without recording changes.

INFO: Information. Provides a display of the nominal supply voltage and installed software version

CHK (with LED): Check. Displays a log of any circuit or dimmer faults (LED illuminates if an error occurs)

ON LED: Illuminates blue when power is applied.

DMX LED: Illuminates red continuously when valid DMX is present. LED flashes when there is no DMX signal.

PHYSICAL

SmartBar Dimensions and Weights

Model	Height		Width		Length		Weight	
	inches	mm	inches	mm	inches	mm	lbs	kgs
SB2-6	2.36	60	2.6	40	42.5	1000	10	4.5
SB4-6	2.36	60	2.6	40	59.5	1500	12	5.5
SB2-10	2.36	60	3.1	80	42.5	1000	15	6.8
SB6-10	2.36	60	3.1	80	87.4	2200	27.8	12.6

SB2-6-B

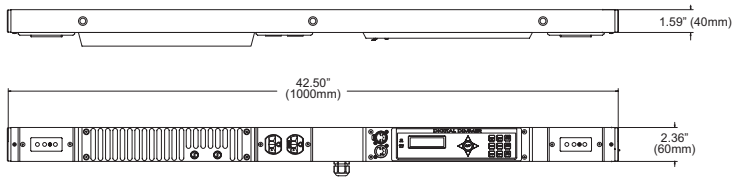

SB4-6-B

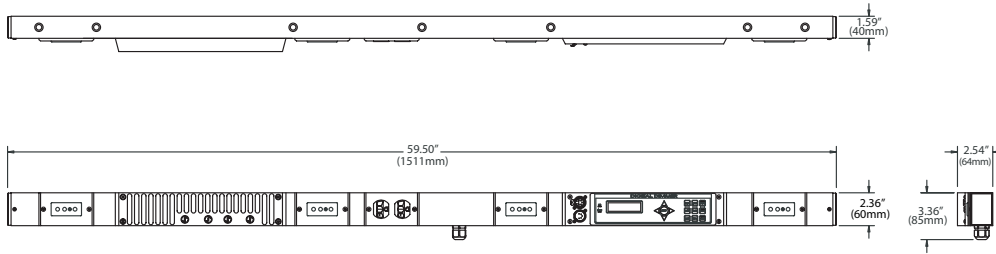

SB2-10M-B

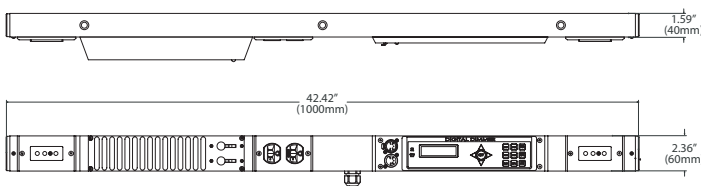

SB6-10M-B

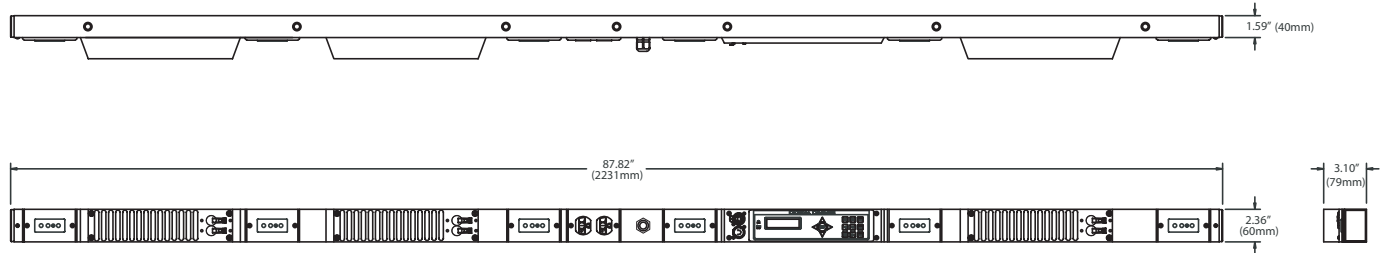

TYPICAL APPLICATIONS

SmartBars on SmartStands

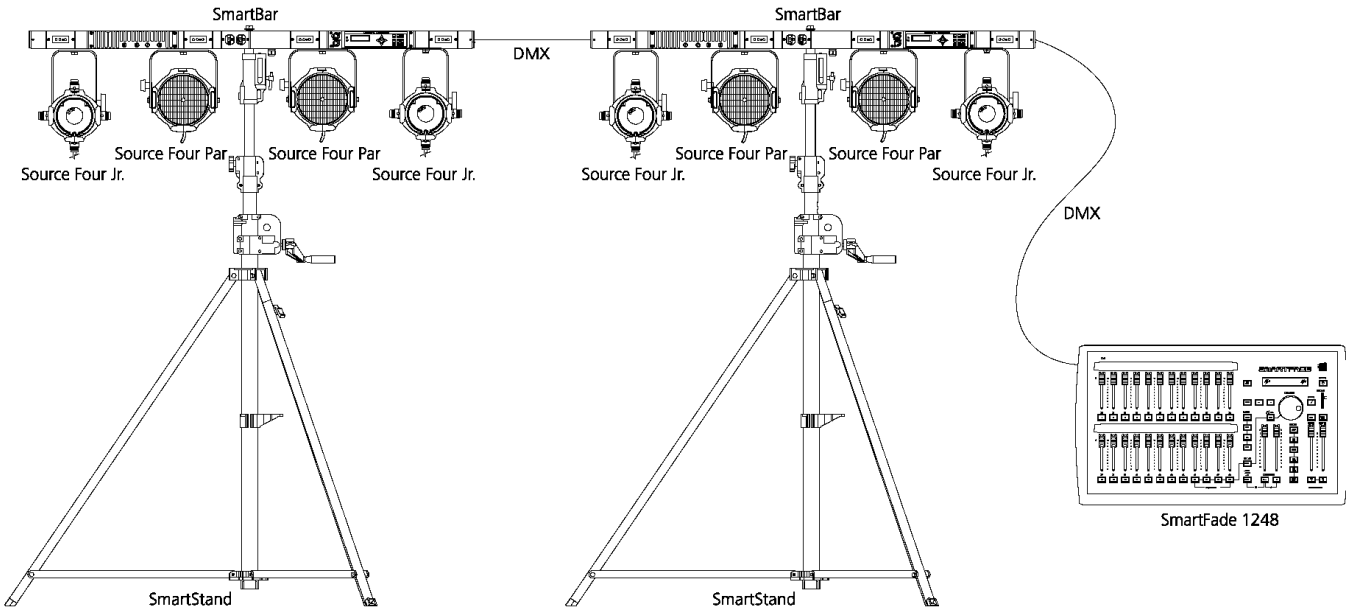

SmartBar with C-clamps on pipe

